

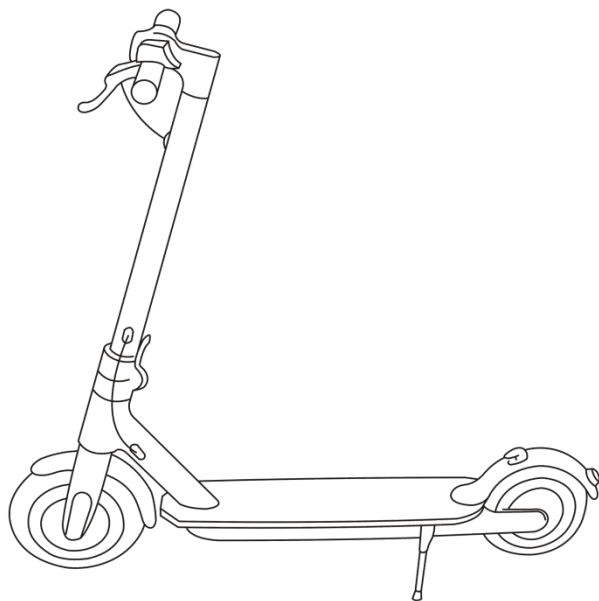



USER MANUAL

ELECTRIC SCOOTER

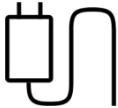

PACKING LIST

			
Scooter x1	Screw x4	Allen key x2	Charger x1

Please carefully check whether the contents is complete.

PARTS INSTRUCTION

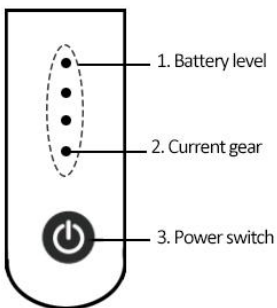
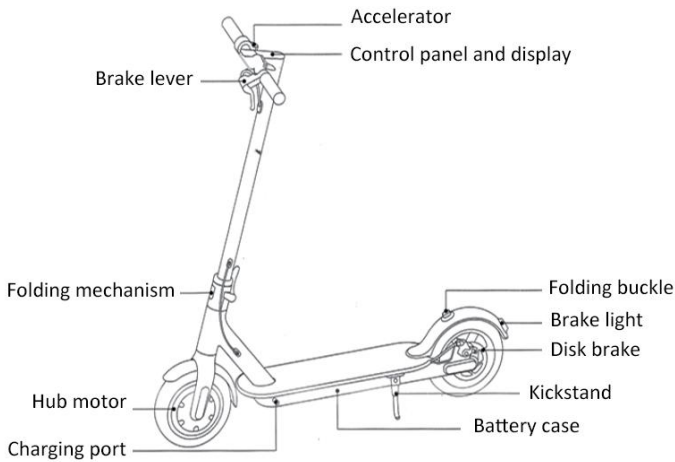

1. Battery indicator: There are four lights to indicate the battery level. Every light represent about 25% power. When the battery is run out, the four lights are all off, and the scooter will slide until stop.

2. Current gear: Double press the switch to switch the gear between first gear and second gear. Top speed of first gear(white light) is 15km/h, top speed of second gear(green light) is 25KM/h.

3. Power switch: Long press the switch to switch the power on/off. When the power is on, short press the switch to turn on/off the headlight.

ASSEMBLY

1. Unfold the scooter and put down the kickstand, then lock the folding mechanism.



2. Install the handlebars with the pipe.



3. Use the Allen wrench to tighten the screws on both sides.



4. After the installation, switch the power on to test the functions.



CHARGING



Open the rubber cap on the port



Insert the charger



After charging, put the cap back

RIDING

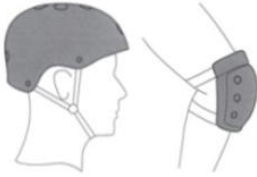

There is a risk of falling and injury during learning, so please wear a helmet and kneepads.



1. Turn on the power and check the power indicator.



2. Stand on the board with one foot, while the other foot pushes against the ground. After the speed reaches 5km/h, the motor is ready for acceleration.

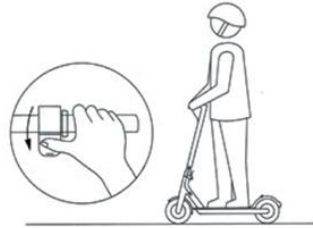

3. Press the accelerator lever slightly, and the scooter accelerates. Put both feet on the board after you can keep balance. Press down the lever to speed the scooter up.

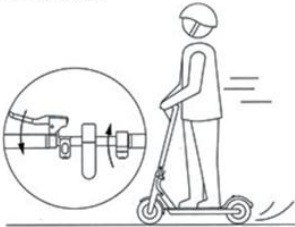

4. Release the accelerator to slow down, energy recovery system will be automatically activated. Squeeze the brake lever at the left handle bar to stop the scooter.

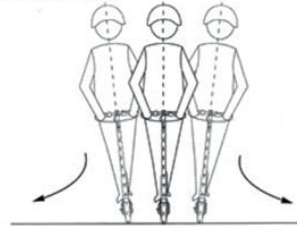

5. Tilt your body slightly to the side you want to turn, and slowly turn the handlebars.

RIDING SAFETY



 Do not ride in the rain



 Please slow down before speed bump, potholes and other uneven surface. Bend your knees to steady yourself on the complex road.

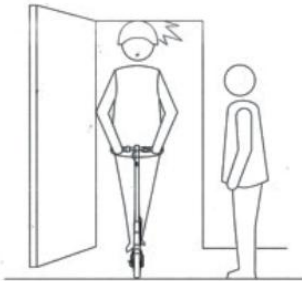

 Watch your head when passing doors.



 Do not accelerate downhill.



 Do not hang heavy objects such as backpack on the handlebars.

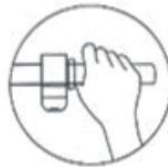

 Do not press the accelerator when you walk on foot.



❌ Do not ride on the roadways.

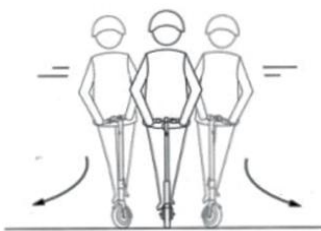

❌ Do not turn suddenly at high speed.



❌ No riding to water above 2cm.



❌ No riding with another people or a child.



❌ Do not step on the fender

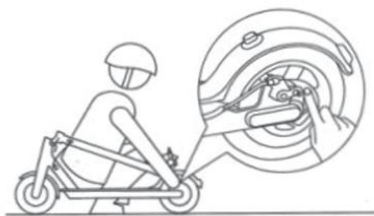

❌ Do not touch the disk brake after brake frequently, it will be very hot!



❌ Do not release the handlebars in riding!



❌ No riding upstairs or downstairs!

- An electric scooter is a sporting entertainment tool, but once you drive it into a public area, there are also possible safety risks. Strictly follow the instructions in this manual when driving to protect you and the others' safety to the maximum extent, and to abide by local laws and regulations.

- At the same time, you need to understand: Once you ride an electric scooter on public roads or other public place, you are facing the risk of accidents, even if you are in full compliance with this safe guide. Like all the vehicles, the faster the electric scooter is, the longer the braking distance. And the foot brake on some smooth surfaces can also cause the wheels to slip and losing balance or even fall. Therefore, It is important to be vigilant and maintain the proper speed during driving, and it is important to maintain a reasonable safety distance with other people and other vehicles. Please be vigilant and drive at low speed before entering unfamiliar terrain.

- Please respect the pedestrians when riding. No frightening pedestrians, especially children. Remind pedestrians and stowing down when you approaching their back. When you approach them face to dace, keep on the side and slow down.

- The seller shall not be liable for personal injuries, accidents, and any other unfavourable events resulting from violating the instructions in this manual.

- Do not lend the electric scooter to a person who has no experience to avoid injuries. Once you let someone to ride the scooter, you are responsible for his/her safety, you must make sure that him/her has carefully read this user manual.

- Please check the electric scooter every time before riding. If you find that any parts is lost, the battery capacity is obviously reduced, the tire is flat or excessively wore or there are any abnormal sounds or malfunctions, do not ride it.

FOLDING

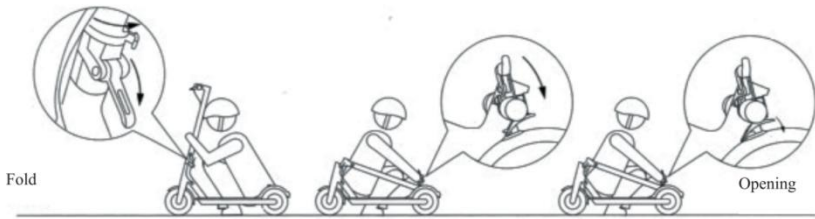

Make sure that the power of electric scooter is turned off, open the folding mechanism, put down the pipe, and hook the handlebars onto the rear fender. When opening you need to press the hook at the rear fender, until the handlebars can be released, then unfold the electric scooter.

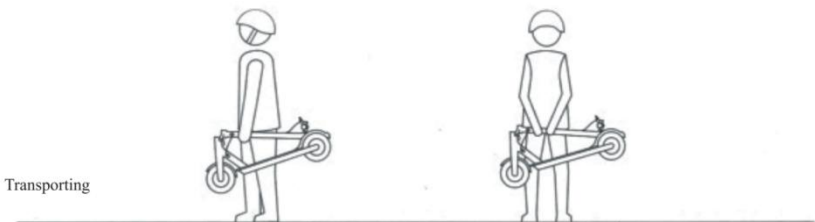

After folding, hold the pipe with one hand or both hands to carry it.

MAINTENANCE

Cleaning and storage

1. Please use a soft cloth dipped in a little water to wipe the scooter body; If it is difficult to clean the dirty, you can use toothpaste and wash with a toothbrush repeatedly, and then use a damp cloth to clean. If there are scratches in plastic parts, you can use sandpaper to polish.
2. Do not use alcohol, gasoline, kerosene or other corrosive, volatile chemical solvent cleaning, otherwise the appearance and internal structure of the body will be seriously damaged, it is forbidden to use a pressure water gun to spray or flush, and ensure that the electric scooter power is switched off all along and the charger has been unplugged and the rubber cap is tightened. Otherwise, it may cause electric

shock or serious failure.

3. When not in use, try to store electric scooter in dry and cool place, try to avoid a long time storage in the outdoor. Sun exposure / overheating / cold outdoor environment will accelerate the appearance of electric scooter and tire aging and reduce the life of electric scooter and its battery pack.

Battery maintenance

1. Do not use other models or brands of batteries, or there may be a security risk.

2. Do not touch the battery contacts, and do not open or expose the shell. Avoid metal objects touching the battery contacts to cause a short circuit. Or it may cause damage to the battery or personal injury or even death.

3. Only use the original charger, otherwise there is a risk of damage or fire.

4. Improper disposal of used batteries may cause serious contamination of the environment. Follow the local regulations to dispose battery pack.

5. Please recharge the battery in time and charge them fully before storage to extend battery life.

6. Do not place the battery over 50°C or below -20°C (for example, do not place the electric scooter or its battery pack in a car under summer sun), and do not put the battery into a fire. Otherwise it may lead to battery failure, overheating, and even fire. If you don't ride it for more than 30 days, please fully charge it, store it in a cool dry place, and fully charge it every 60 days, or the battery may be damaged, and this damage is not within the warranty.

7. To avoid the full exhaustion of power, please recharge the battery in time. It can greatly extend the battery life. In addition, at room temperature, the battery pack can offer a higher mileage and performance. And if it is used in an environment below 0°C, battery life and performance will drop. Typically, at -20°C, the mileage may be only half of it at room temperature. And as the temperature rises, the battery mileage will be restored.

8. A fully charged electric scooter will deplete its stored power after about 120-180 days of standby, if not timely charged before its power is depleted, it is likely to lead to excessive battery discharge damage, this damage is irreversible, and can not enjoy free warranty. (Note: non-professional personnel is prohibited to remove the battery

pack, or it may lead to serious security incidents due to electric shock or short circuit!)

Disk brake adjustment



If you feel the brake is too tight, please use the M5 Allen wrench anticlockwise to release the screw on the disc brake, adjust the brake cable to make the tail slightly shorter, and tighten the screw. If you feel the brake is too loose, release the screw, adjust the brake cable to make the tail slightly longer, and then tighten the screw.

debugging

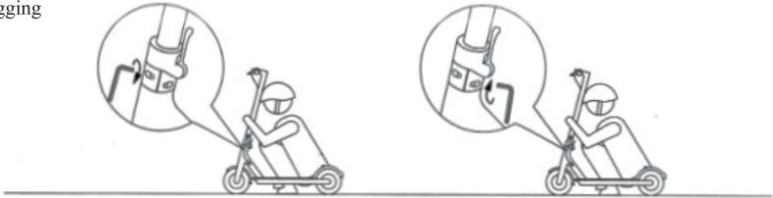

If the pipe shakes, use the Allen wrench to fasten the two screws on the folding mechanism.

PUMP



If the tire has gone down, remove the cap on the inlet, connect it to an air pump to inflate it.

PARAMETERS

Performance index	Item	Parameters
Product dimensions	Length x Width x Height	1080 * 430 * 1140mm
	Folding: Length xWidth xHeight	1080 * 430 * 490mm
Product weight	Weight	12.5KG
Riding requirements	Max loading	120KG
	Applicable age	16-50 years old
	Applicable height	120-200cm
Main parameters	Max speed	25KM/H
	Range (km)	18-25KM
	Climbing ability	15°
	Applicable terrain	Flat dirt road, no higher than1cm steps, no more than 3cm wide channel
	Working temperature ℃	-10~40
	Storage temperature ℃	-20~45
	Protection levels	IP54
Battery parameter	Rated voltage (VDC)	36V
	Max.charging voltage (VDC)	42V
	Rated capacity (Wh)	280
	Smart battery management system	(Temperature anomaly / Short circuit /Undervoltage auto dormancy /Overcurrent /Double overcharge /Double protection)
Motor parameter	Rated power (W)	250
	Max power (W)	500
Charger parameters	Rated power (W)	71
	Rated input voltage (VAC)	110~210V
	Rated Output Voltage (VDC)	42V
	Rated current (A)	1.7V
	Product Certification	CE .ROSH
	Charging time	About 6 hours

Performance index	Item	Parameters
Product dimensions	Length x Width x Height	1080 * 430 * 1140mm
	Folding: Length xWidth xHeight	1080 * 430 * 490mm
Product weight	Weight	12.5KG
Riding requirements	Max loading	120KG
	Applicable age	16-50 years old
	Applicable height	120-200cm
Main parameters	Max speed	25KM/H
	Range (km)	18-25KM
	Climbing ability	15°
	Applicable terrain	Flat dirt road, no higher than1cm steps, no more than 3cm wide channel
	Working temperature ℃	-10~40
	Storage temperature ℃	-20~45
	Protection levels	IP54
Battery parameter	Rated voltage (VDC)	36V
	Max.charging voltage (VDC)	42V
	Rated capacity (Wh)	280
	Smart battery management system	(Temperature anomaly / Short circuit /Undervoltage auto dormancy /Overcurrent /Double overcharge /Double protection)
Motor parameter	Rated power (W)	250
	Max power (W)	500
Charger parameters	Rated power (W)	71
	Rated input voltage (VAC)	110~210V
	Rated Output Voltage (VDC)	42V
	Rated current (A)	1.7V
	Product Certification	CE ,ROSH
	Charging time	About 6 hours

Note: some parameters vary according to different riders and environments, they are for reference only.

TOXIC AND HARMFUL SUBSTANCES

Name of component	Harmful substance					
	Plumbum (Pb)	Mercury (Hg)	Cadmium (Cd)	Hexavalent chromium (Cr(VI))	Polybrominated biphenyls (PBB)	Polybrominated diphenyl ethers (PBDE)
Charger	X	○	○	○	○	○
Battery	X	○	○	○	○	○
Air tap	X	○	○	○	○	○
Charging port	X	○	○	○	○	○
Master control board	X	○	○	○	○	○
Instrumentation circuit board	X	○	○	○	○	○
Wheel motor	X	○	○	○	○	○
Car frame	○	○	○	○	○	○
Tire	○	○	○	○	○	○

This Table is formulated in line with the SJ/11364.

○: Indicate that the content of this harmful substance in all homogeneous materials of this component is below the limit prescribed in GB/T 26572.

X: Indicate that the content of this harmful substance in at least one homogeneous materials of this component is beyond the limit prescribed in GB/T 26572.

APPLICATION DOWNLOAD

Search LENZOD on app store or scan the QR code to download the APP and install.

LENZOD



IOS



Android